

Manual

Soloplaner SH 230



⚠ Warning! Failure to follow the instructions can cause serious injury.

❗ For your own safety, read this manual before starting to use this equipment.



 **LOGOSOL**
Swedish Wood Processing Products

Thank you for choosing a machine from LOGOSOL.

Logosol has manufactured small sawmills for chainsaws since 1988. Our most renowned product is the Logosol Sawmill, which is the world's most sold sawmill.

Logosol has a broad product programme for small-scale wood processing. This programme includes machines and accessories that enable you to be in charge throughout the entire process, from tree felling to finished wood products.

In addition, Logosol manufactures cutting equipment for larger sawmills: *the Rip Saw Assistant*, a cutting aid which is mounted above the circular saw blade, and a *Stack Cutter* for industrial use.

We also have a selection of special planers/moulders, e.g. *PH 260*, which planes and profiles the four sides of a board in one single operation. Call Logosol, and we will send you information about our entire wood processing programme. If you are interested in a certain product, we have video films that show you the machines in action. You can see short versions of the films directly on our website. If you want to have the films in full version, we will send you a video tape or DVD by postal mail. This is, of course, free of charge.

You have bought the *Soloplaner, SH 230*, a combined planer and bench saw which dimensions the width and height of a board in one single operation, and is also able to mould the board. If you have any questions about the *Soloplaner*, do not hesitate to contact us at Logosol. Our aim is to make you yet another satisfied owner of one of our products.

We wish you all the best with your new machine!

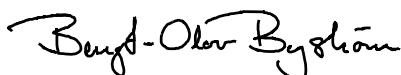

Bengt-Olov Byström, MD and constructor



Printed on chlorine-free, recyclable paper, using vegetable-oil inks.

LOGOSOL is constantly developing its products. For that reason we reserve the right to make changes in design and construction of our products.

Text: Mattias Byström

Document: SH 230 9810

Illustrations: Bo Mårtensson and Bo Hellborg

Translation: Anna Olsgren Byström

Latest revision: 2006-10-10

Manual, article no: 0458-395-0580

Copyright 2001 LOGOSOL, Härnösand, Sweden

Table of Contents

Safety Instructions	4
Safety Distance	5
Tools Required	5
Overview	6
Machine Description	7
Setting up the Soloplaner	7
Handling Chips and Sawdust	7
In- and Out-Feed Tables	8
Electrical System	9
Cutter Head with Planing Knives, Moulding Knives, and Saw Blade	9
Overview – Cutter Head	9
Planing Knives	10
Moulding Knives	10
The Poly-V Belt	11
Changing Saw Blade	12
Maintenance	13
The Feed	13
Four Functions	14
Planing Tips	14
Worth Knowing...	15
Safety Instructions for Moulding Knives	16
Knife Mounting Examples	17
EC Declaration of Conformity	18
Circuit Diagram	18

Supplements to this Manual

A Booklet about the Soloplaner

In this booklet you can read about all the possibilities of the Soloplaner.

Knife Mounting with Janne

An easy step-by-step description with illustrations. This is not a manual, but it gives a hint of how easy it is to plane and mould boards.

Knives and Accessories

Logosol has a wide selection of accessories, such as chip extractors, hoses, in- and out-feed tables, stands, and other necessary accessories. Logosol has also developed a wide range of moulding knives, especially adapted for the Soloplaner. You can find all this in the catalogue "Logosol Planers/Moulders and Accessories" (art. no: 7500-000-1000).

❗ All supplements can be ordered free of charge from Logosol.

Safety Instructions



For your own safety, do not begin working with the machine before having read and understood the entire manual. Do not let anyone who has not read the instructions use the equipment.



Risk of cutting injuries. Use protective gloves when handling the knives and the saw blade. It is especially important that you wear gloves when loosening or tightening the lock screws for the knives (since there is risk that you slip with the spanner), and when handling the cutter head while changing saw blade.



Use approved hearing protectors. Hearing can be impaired after only a short exposure to high-frequency sounds. Use approved eye protectors. Splinters and wood pieces can be hurled out with great force.



Warning! Cutting tools. Never stick hands or tools above or beneath the machine table (11*), or into the chip outlet while the machine is running.



This symbol means "WARNING!". Pay extra attention when this symbol appears in the text.



This symbol is followed by an admonition. Pay extra attention when this symbol appears in the text.

 **If used incorrectly, the Soloplaner can cause serious injury.** Always be focused and careful when using the machine.

Never stand behind the work piece when it is being fed into the machine. The board can be hurled out of the machine. Also knots, splinters or steel pieces can be hurled out with great force. Always stand at the side of the in-feed table.

Only one work piece at the time may be fed through the machine.

Make sure that the machine is set up so that the feed roller (5) takes a firm hold of the work piece. Do not feed into the machine work pieces that are so conical that the feed roller risks losing hold.

Never place your hands or tools over or under the table while the machine is running.

Before starting the machine:

- Make sure that the cutter can rotate freely, and that no tools or loose parts are left in the machine.
- Make sure that the cover is properly closed, and that both the lock knobs are tightened.

- Make sure that all knobs, screws, nuts, fences, chip carriers, cutters, knives, the saw blade, protective covers, in- and out-feed tables, etc. are properly tightened/attached, that the chip hoses are mounted and that you have switched on the chip extractor.

In this manual, the phrase "**disconnect the power**" means that you shall stop the machine, pull out the cable with the CCE plug, which supplies the machine with electricity, and place it so that no unqualified operator can connect it to the machine. The cable shall also be placed so that you cannot tread or trip on it.

Disconnect the power to the machine by pulling out the plug, and wait for the cutter head to stop before:

- opening the cover to change planing/moulding knives and saw blade, or to clean or carry out any other operation above or beneath the machine table.
- changing belts or carrying out any other servicing or cleaning operation.
- moving the machine.
- leaving the machine unsupervised.

A chip hose and chip extractor **shall** be connected to the chip outlet of the machine, and be fastened in a reliable way, e.g. with hose clamps.

The machine **must** be equipped with in - and out-feed tables of a length of at least 0.8 m (2.6 ft).

Do not wear loose-fitting clothing or anything else that can get caught in the machine's moving parts. If you have long hair you should put it up in a reliable (and nice) way.

Never use the machine in poor visibility conditions. Always work in good lighting.

Do not use the machine under the influence of alcohol or other drugs.

Keep the work site tidy. Do not leave anything you can trip over lying on the ground.

Never put your hands or any tools on the machine table while the machine is running.

Do not climb onto the machine.

Do not tread on the machine's power cable. The cable should be secured off the ground.

Place the machine so that the emergency stop (10) is not blocked.

For the greatest electrical safety, an **residual circuit breaker** should be fitted.

The machine must not be modified or added to. Only use original parts supplied by Logosol. **After servicing, the machine must be restored to its original condition.**

**Numbers within parentheses refer to the overview picture on page 6.*

The machine may not be used in temperatures below 0°C (32°F).

The machine's warning labels are there for everyone's safety. Damaged or illegible labels must be replaced.

Saw blades or knives that are not sharp increase the risk of an accident.

Lifting instruction: It takes two persons to lift the machine. Take hold of the machine under the lower edge of the green chassis on the in- and out-feed side.

⚠ Risk of kickbacks.

🔧 Minimum length of the work piece: 300 mm (12").

🔧 Acquaint yourself with all functions and setting possibilities before starting to use the machine.

! Safety Distance

The safety distance for persons other than the operator is 3 m (10 ft) from the sides of the machine or 6 m (20 ft) from the out-feed side during operation. The in-feed side should be turned towards a wall or some other barrier that can stop the work piece if it should be hurled out of the machine. The wall or barrier should be no more than 8 m (26 ft) from the machine, but preferably closer if short work pieces are to be processed. Use some kind of demarcation so that no one can unintentionally come within the risk area between the machine and the wall on the in-feed side.

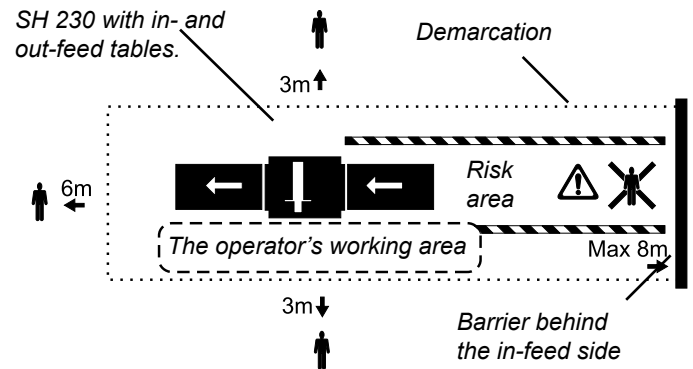

Tools Required

- 30 mm spanner
- 10 mm spanner
- 4 mm Allen key
- 6 mm Allen key
- 13 mm Ring spanner
- 10 mm Ring spanner
- Adjustable spanner
- Hook spanner for the saw blade
- Setting block for the planing knives
- Vernier calliper
- Ruler 30-50 cm (12-20")



Make a tool board for the tools you use, and place it near the planer so that you can easily reach it. Look at the tool board before starting the machine in order to make sure that no tool is missing. Perhaps there is a tool left inside the machine!

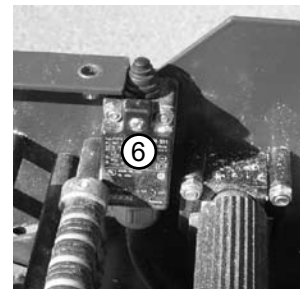
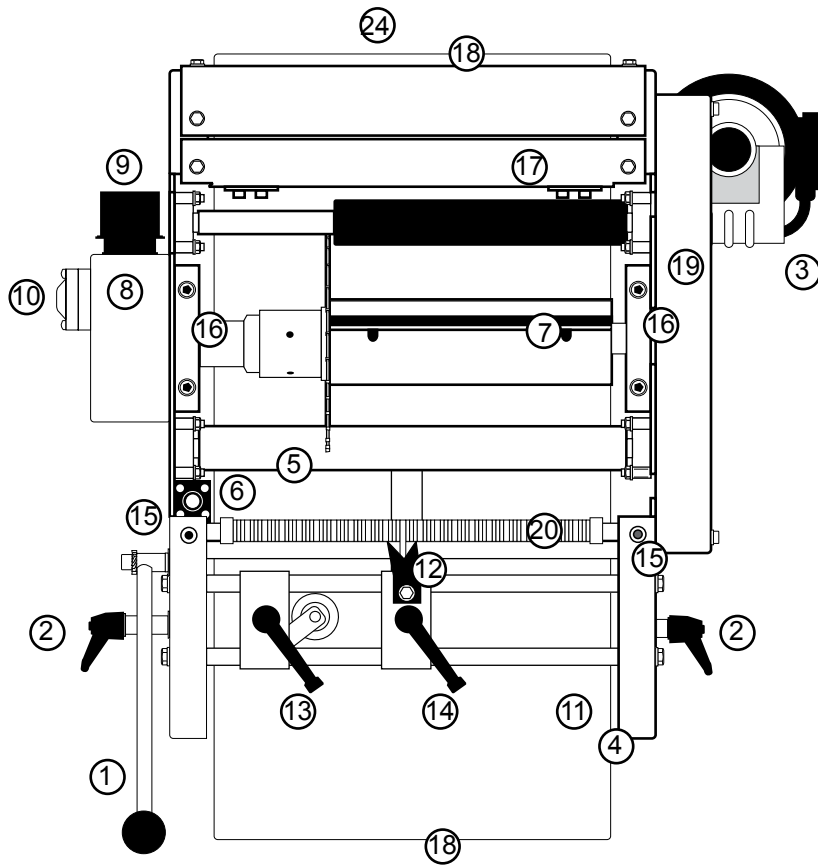

Overview

Pos.	Description	Article no.
1	Table lever	7202-001-0218
2	Locking handle	7202-001-0226
3	Worm gear	7202-001-0096
4	Height indicator	7202-001-0220
	Height scale	9999-100-0517
5	Feed roller	7202-001-0084
6	Safety switch	7202-001-0068
7	Combi-cutter	7202-001-0232
	Planing knife SH 230	7000-002-8230
	Circular saw blade SH 230	7200-000-1300
	Hook spanner	7202-001-0060
8	Electric box, complete	7202-001-0066
9	Phase reverser	
10	Start, stop, and emergency stop control	
11	Table	7202-001-0212
12	Fence with double pointer	7202-001-0104
	Width scale	9999-100-0518
13	Pressure roller, complete	7202-000-0100
14	Fence	7202-001-0110
15	Lock screw for cover M6x20	7202-001-0035
16	Two-part bearing housingD43	7202-001-0236
	Two-part bearing housingD56	7202-001-0234
17	Out-feed roller (rubber)	7202-001-0092
18	In-/out-feed table mounts	7202-001-0216
19	Chain tensioner	7202-001-0086
20	Kick-back guard, complete	7202-001-0300
21	Poly-V belt SH 230	7202-001-0079
22	Belt tensioner	7202-001-0073
23	Turnable chip duct 100mm	7200-000-1400
24	Safety flap	7202-001-0020

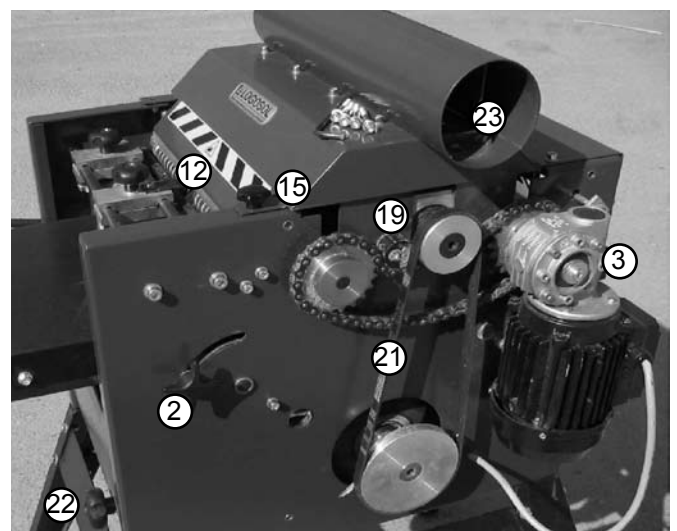
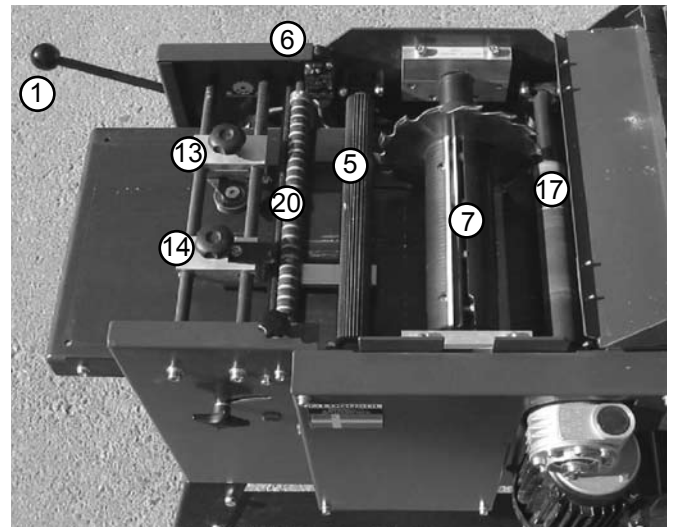

Machine Description

SH 230 is a wood dimensioning machine that can simultaneously process two sides of a work piece, and in some cases even three sides.

The machine is based on a sturdy frame with a steel plate planing table. The table is suspended in the frame on double parallel struts. Via a lever, the table can be precisely raised and lowered.

Supported by the planing table, the work piece is fed through the machine by two rollers. These feed rollers are suspended on springs and fitted into the frame. The work piece is laterally guided by one adjustable fence and one spring-loaded roller.

The machining of the wood is made by a special combination of a cutter head and a circular saw blade that is unique to *SH 230*. So that it may be easily removed, the cutter is fitted to the frame by two bearing housings that can be readily taken apart. The cutter head uses push-cut milling and is driven by a powerful electric motor via a Poly-V belt transmission with 1:2 reduction.

The cutter head and the feed rollers are covered by a raisable protective cover. A safety switch prevents the machine from starting if the cover is not locked. Above the cutter head, there is a duct to which a chip extractor can be connected. The chip hose can be fitted to either the right or the left side of the machine.

The machine is equipped with a kick-back guard on the in-feed side and a safety flap on the out-feed side.

Setting up the Machine

Inspect *SH 230* immediately on reception. Any transport damage must be notified immediately to the freight company.

As most of the machine's structure is protected against rust, it can stand in the cold. However, extra maintenance is then required – parts that are not rust protected must be lubricated (see *Maintenance and Lubrication Points*).

- If you do not have the *SH 230* stand, place the machine on a firm and level stand that raises it at least 50 cm off the ground. There should be open space under the machine preventing chips from accumulating around the motor. Bolt the machine to the stand through the holes in the frame's base.
- Make sure that there is room on the in-feed and out-feed side for the longest boards that are to be planed, and that there is space provided for servicing and board stacks.
- Fix the machine's power cable to the ceiling or protect it in some other way. Never tread on the cable. The machine should be connected via a residual current breaker.
- Ensure that the lighting is first-class. You should have good main lighting, and also have a powerful light above the machine. Ensure that there is no risk of being dazzled by the light.

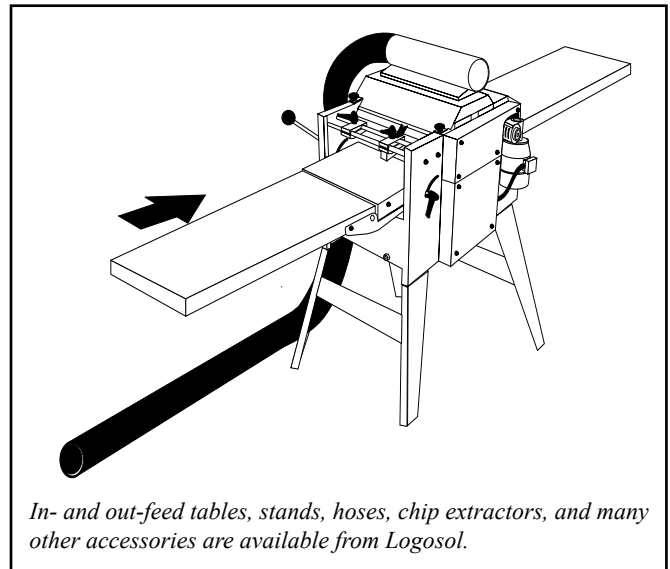

Handling Chips and Sawdust

SH 230 should be connected to a chip extractor with a capacity of at least 800m³/h. Logosol has a suitable 240V 2-phase chip extractor of 0.5kW and 840m³/h, (art. no. 2000-000-2005). This extractor has no chip collection bag, only an inlet and an outlet with a diameter of 100 mm (4"). The reason for this is that a chip bag gets full so quickly. Build a chip pocket or blow the wood debris directly into a trailer or the like. There has to be an air outlet in your chip container (e.g. a fine-meshed net, or a filter if you collect the wood debris indoors). Poor extraction capacity is often due to a too limited air flow out of the chip container. If you keep the machine in a heated room, the chip extractor will soon cool the room if you do not direct the air back into the facility.

Dust emission and risk of fire have to be taken into consideration when collecting wood debris.

⚠ Risk of fire, and dust emission when collecting wood debris.

- ❗ Consult your local authority about the regulations in your district.
- Connect the chip hose, and fasten it with hose clamps both at the planer end and the chip extractor end. Use the Flexi Hose from Logosol (length: 3m, art. nr. 7000-000-1015) which has a smooth inside improving the flow.
- If you want to convey the wood debris a long way, you should place the chip extractor close to the planer so that you can use as short hose as possible. Convey the chip in a sheet metal pipe, which reduces resistance for the air flow.
- You can unscrew the chip duct on the cover and turn it so that you get the hose connection either on the right or on the left side of the machine.
- ❗ Place the chip extractor so that its power switch is easily accessible.

Tips: As a temporary solution you can use an old duvet cover, with tied up corners, as a chip collection bag.

In- and Out-Feed Tables

Logosol can supply ready-made in- and out-feed tables (1pc, art. no. 7202-001-0400). You can also build your own feed tables. To ensure that no knife marks are left on the ends of work pieces, it is vital that the in-feed table, the planing table, and the out-feed table are exactly level with each other.

Behind the edges of the planer table there are angle irons that can be turned outwards to serve as feed table fasteners. A feed table can be made from a long planed board (e.g. 2x8"). This should be fitted so that its upper surface is at exactly the same level as the top of the planing table. The other end of the board can be rested on a height-adjustable trestle.

ⓘ The in-feed table also serves as a safety measure, as it prevents the operator from standing in the area where there is risk of the work piece being hurled out of the machine.

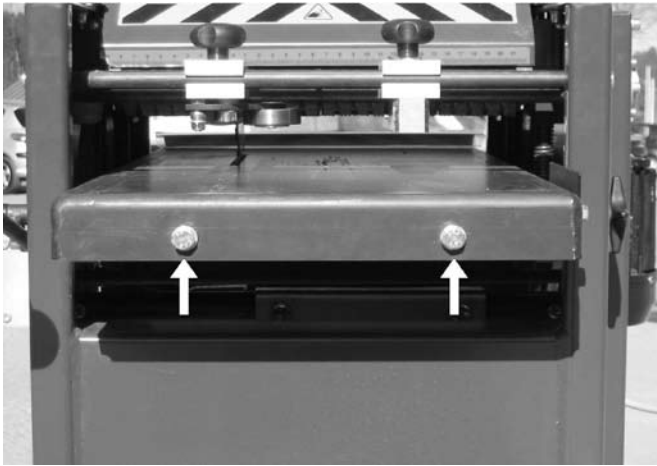

On the inner side of the table edge there is an iron angle. When this is shifted to the outside, it serves as support and mount for your home-made feed tables. Make sure that they are at the same level as the planing table.

Instructions for Mounting of Original Feed Tables SH 230

Unscrew the angle irons, which are fitted to the front and rear edge of the planing table.

Place a straight board into the machine, letting it protrude over the in- and out-feed table. Fix the board by raising the planing table. Loosen the screws (1) and push the feed table up against the board. Tighten the screws. Loosen the screws (2) and adjust the angle of the feed table.

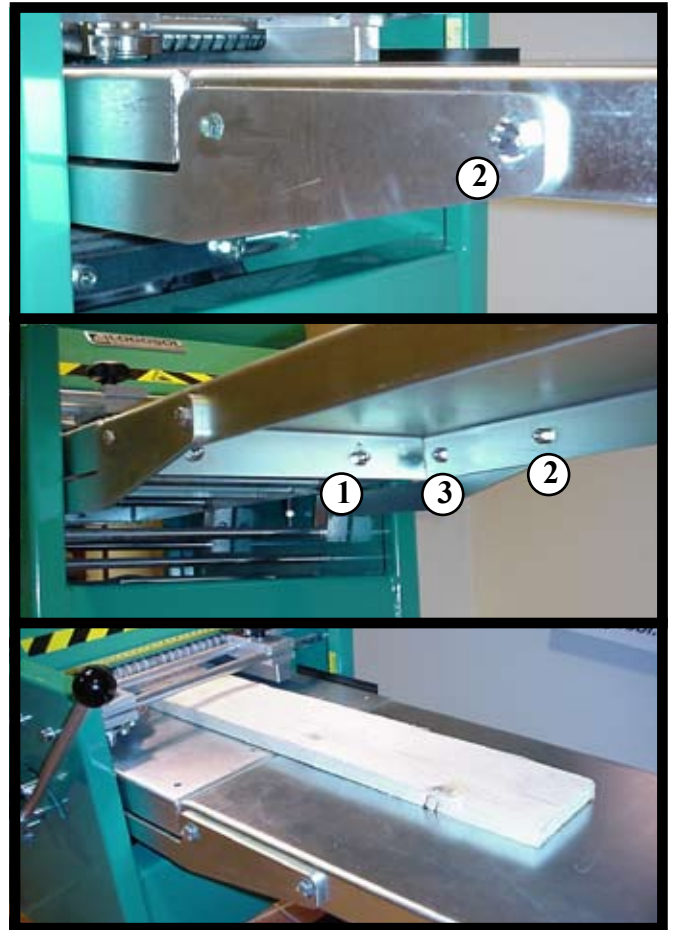

1. M8 screw
M8 washer
M8 lock nut
2. M8 screw
M8 washer
M8 lock nut
3. M10 screw
M10 washer
M10 lock nut



SH 230 equipped with in- and out-feed tables (2x 7202-001-0400), stand (7200-000-1000) and a set of lockable castors (7500-000-1025).

Electrical System

⚠ Lethal voltage! Only qualified electricians are authorised to open/access the machine's electrical system.

- ❗ The green button starts the machine.
- ❗ The red button stops the machine, and also serves as an **emergency stop**. The buttons must be easily accessible and may not be blocked.

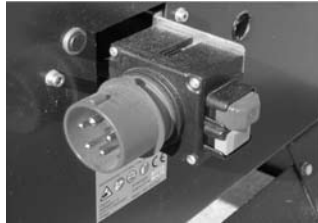

- ❗ Perform safety check (*Before Starting the machine, see Safety Instructions*).
- ❗ Make sure that all cables, plugs and sockets are in good condition, and that you have the proper type of voltage, frequency, and fuse.

Connect the machine, 16 A European plug 400 V. Make sure that the machine is running in the right direction (see label on the inside of the frame at the in-feed side). Lower the table to its lowest position, so that you can see the saw blade from the in-feed side. If it is running in the wrong direction, pull the plug out of the machine, and reverse the phases by turning the white plastic disc that holds two of the pins. Use a large flat screwdriver.

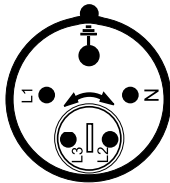

- ❗ The plug does not need to be opened to reverse the phases.
- ❗ The machine is equipped with a zero voltage switch. Automatic restart after a power cut is prevented.
- ❗ If the machine does not start, it can be due to the cover not being completely closed.

Cutter Head with Planing Knives, Moulding Knives, and Circular Saw Blade

- ❗ Before opening the planer's cover, ensure that the power is disconnected and that the cutter head is not rotating. Use protective gloves. This is especially important when you are loosening screws that are tightly screwed, or when you are tightening the screws (see *Safety Instructions*). Be careful of the planing knives. You can easily get cut by those, even when touching them lightly.

As accessories there are short knife clamping gibs that enable height adjustments of the moulding knives. Without this accessory, the moulding knives' profile depth is set by adjusting the cutting depth of the planing knives.

After you have changed planing knife, moulding knives or saw blade:

- ❗ Make sure there are no tools left inside the machine.
- ❗ Make sure that the cutter head can rotate freely when the cover is closed. When the power is cut, you can check this by rotating the belt disc on the motor. You can reach the underside of the belt disc if you stick in your hand under the belt's protective cover.
- ❗ Do you remember the safety instructions on pp. 4-5?

Overview – Cutter Head

Pos. Description

- A Belt disc
- B Bearing
- C Knife clamping gib / Chip breaker
- D Locking screw
- E Cutter knife
- F Adjusting screw
- G Circular saw blade
- H Thrust washer
- I Threaded sleeve
- J Moulding knife
- K Short knife clamping gib

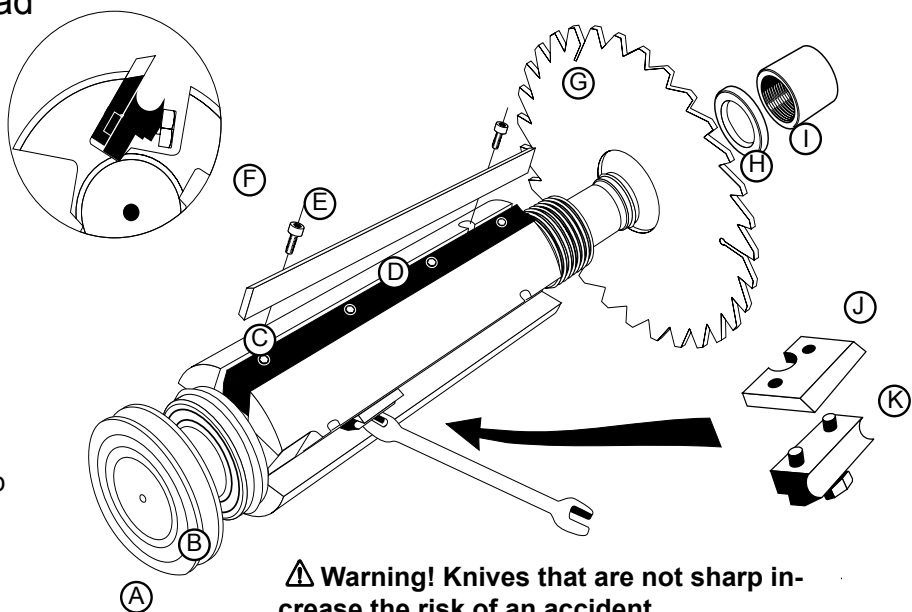

⚠ Warning! Knives that are not sharp increase the risk of an accident.

Planing Knives

❶ Read the part *Cutter Head with Planing Knives, Moulding Knives and Circular Saw Blade*.

The planing knives that are mounted in the machine have been set for use on delivery. However, the knives must be ground regularly for the machine to work properly.

Removal: Loosen the locking screws (D) and press the chip breaker down (C). Raise the planing knife, using the adjusting screws (F).

Grinding: Always grind the knives in pairs. This is to ensure that they have the same width (min. 15 mm, or 0.6"). If they do not have the same width, vibrations can arise in the cutter head. The grinding angle should be 40°.

Mounting: Before mounting knives, you should thoroughly clean the knives, the chip breaker, and the cutter head. Place the chip breaker in its track. Position the planing knife so that the heads of the adjusting screws are in the indentations in the side of the knife, and screw the knife down with the adjusting screws.

Only tighten the chip breaker's locking screws loosely, so that the knife can be adjusted vertically. When the height adjustment is made, tighten the locking screws a little at a time, until all screws are properly tightened. Finally, carefully screw the adjusting screws down until they meet resistance. Do not overtighten. This will cause the knife to crack.

Rough height adjustment: With the help of the adjusting screws, set the height of the knife so that the lower edge of the ground surface on the knife's back is level with the cutter head.

Fine height adjustment: Pass the setting block (art. no. 7500-000-1020) sideways over the cutter head. The correct height is set when the knife touches the block. Measure with the block on both sides and in the middle of the knife.

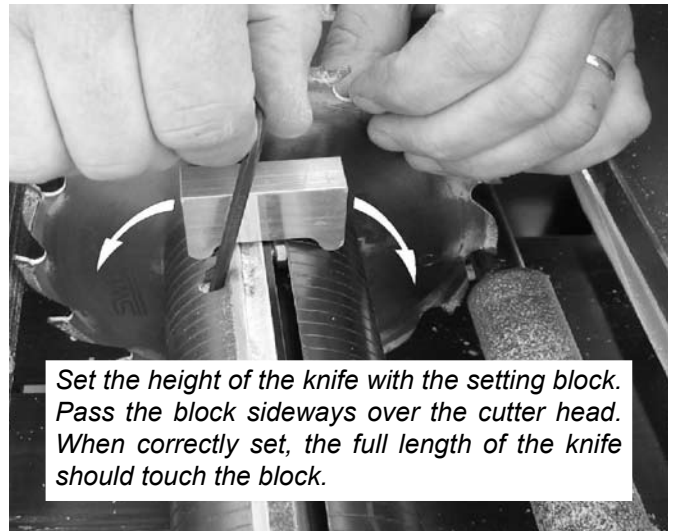
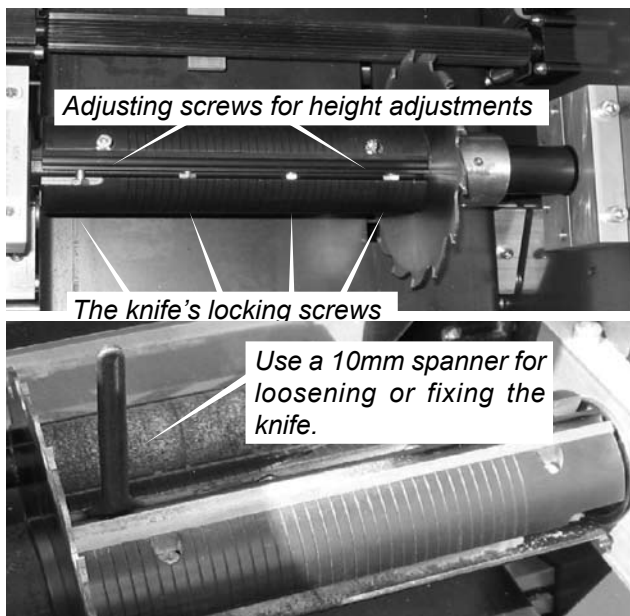

❶ When the setting is finished, tighten the chip breaker's locking screws properly. Fully tighten the adjusting screws.

Moulding Knives

⚠ **Warning! Lack of balance in the cutter head creates vibrations that can damage the machine and cause personal injury.**

❶ The moulding knives must always be mounted in pairs so that the cutter head keeps its balance.

Mounting:

- Assemble the knife clamping gib (K) and the moulding knife (J).
- Insert the knife clamping gib and the moulding knife in the wide end of the track in the cutter head.
- Push the knife and the gib along the track and fasten them by turning the screw on the back of the gib anticlockwise so that it presses against the side of the track.
- ❶ The locking screw must be fixed in the narrow track. It must not be fixed in the wide end of the track.
- Measure the lateral position of the knife and fit an identical knife in exactly the same position on the opposite side of the cutter head.

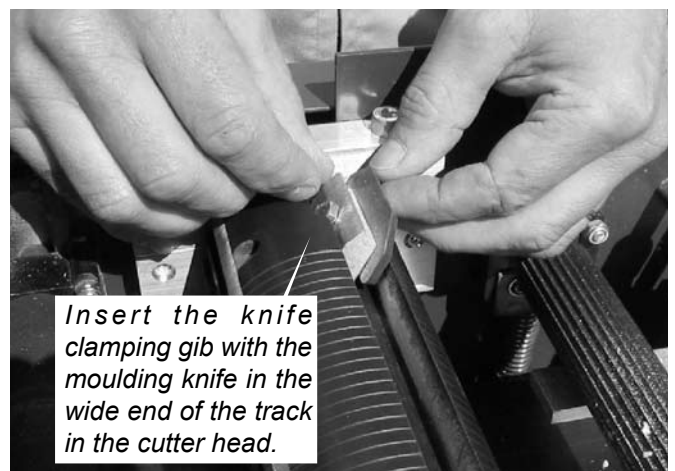

The Poly-V Belt

The planer's motor is suspended on a steel pipe. The pipe is fixed in the frame by deforming each end of it with bolts that run from top to bottom. It may be necessary to loosen these bolts when removing the belt.

To prevent belt slippage, it may be necessary to adjust the belt tension. This is done by using the knob on the front of the frame.

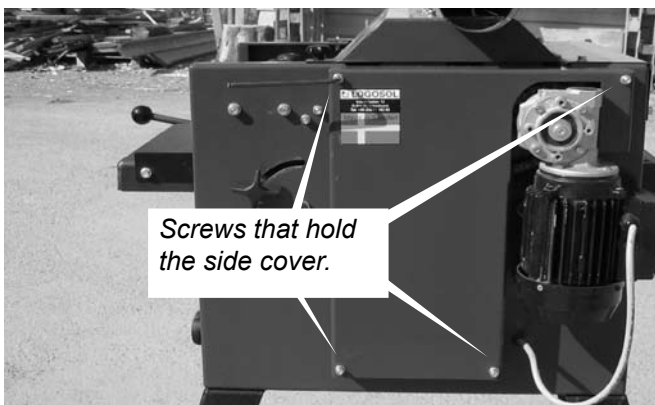
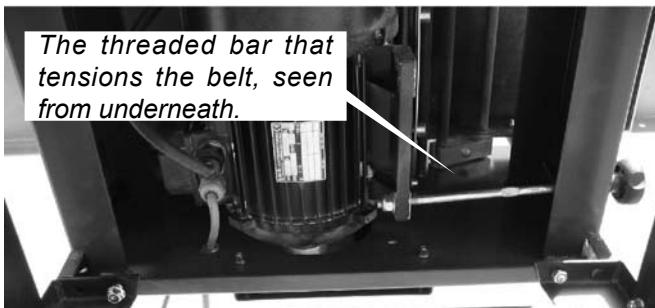
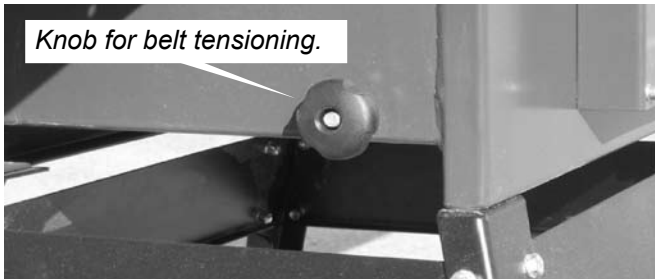

Removing the Belt

⚠ Disconnect the power.

Remove the side cover, which protects the feed chain and the belt transmission.

Loosen the belt tension by turning the knob on the in-feed side of the machine.

Turn the belt by hand simultaneously pulling it outwards, and the belt will come off the belt discs.



Fitting the Belt

Hold the belt under the lower belt disc. Slightly lift the lower disc at the same time as you are placing the belt on the upper belt disc. Lift and turn the lower belt disc until the belt is completely positioned on the upper disc.

Turn the belt by hand simultaneously pushing it laterally until it is centred on both the belt discs.



N.B., The feed rollers' chain does not have to be removed when changing the belt.

Tension the belt by turning the knob. Carefully tighten the screw that is fixing the pipe on which the motor is suspended, if you have loosened it before removing the belt.

Changing Saw Blade

❶ Read the part *Cutter head with Planing Knives, Moulding Knives and Saw Blade*.

Removal: Remove the protective cover for the belt transmission.

Loosen the belt tensioner and force the Poly-V belt off the cutter head's belt discs.

Place two 195 mm long board offcuts between the rollers on the planing table and raise the table carefully until the cutter head catches on the boards. Using both locking handles, lock the table in this position. Loosen the threaded sleeve with a hook spanner.

Remove the cutter head's bearing caps and carefully lift the cutter head out of the machine. Unscrew the threaded sleeve completely, and pull off the saw blade.

Mounting: Thoroughly clean the bearings, the bearing housings, and the cutter head. Using the thrust washer and the threaded sleeve, mount the saw blade on the cutter head.

Only use saw blades supplied by Logosol.

Place the cutter head in the bearing housings. The guide pins ensure that the cutter head comes in the correct position. Tweak the lateral position of the cutter head. Refit the bearing caps and fully tighten the screws. Force the Poly-V belt over the belt discs, and check that the cutter head can rotate freely. Fit the protective covers. Place the board offcuts between the feed rollers and raise the table until the cutter head catches on them. Lock the table in this position and, using the hook spanner, tighten the threaded sleeve.

The bearing housings lower parts can be vertically adjusted about a millimetre. The space between the cutter head and the table should be the same along the entire length of the cutter head. This has been set before delivery, and normally it does not have to be additionally adjusted.

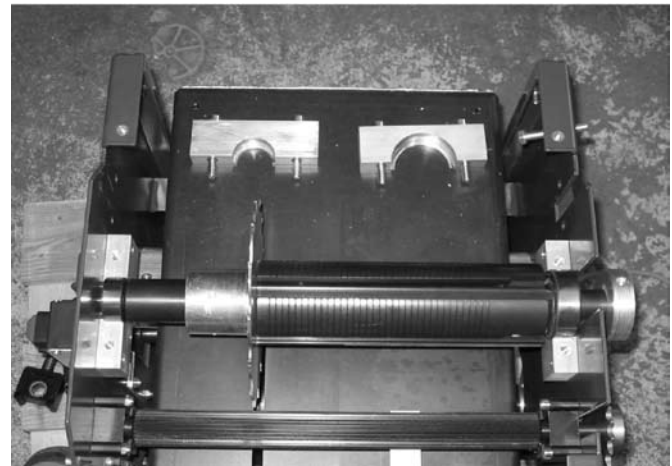
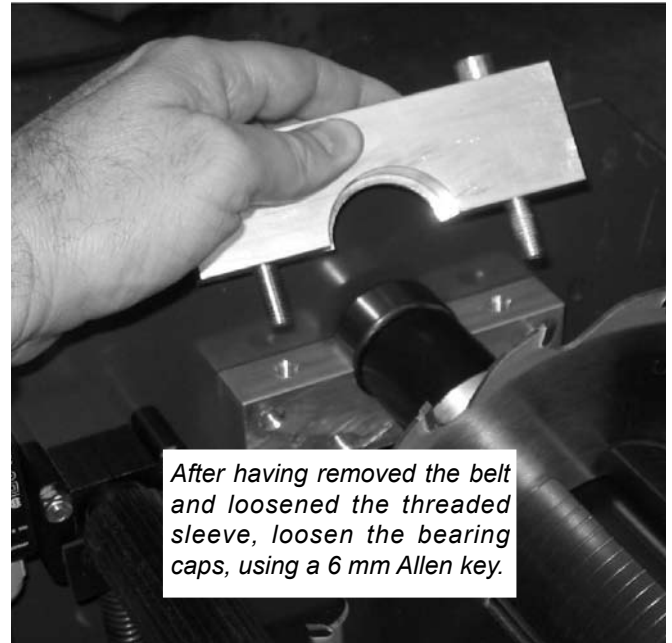
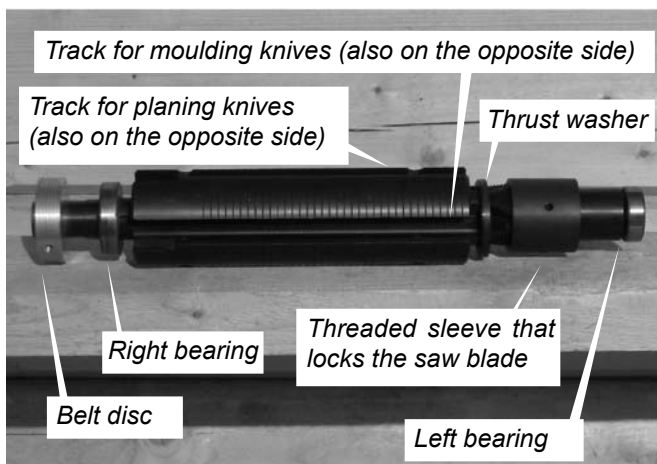

If the threaded sleeve is too tight, tap on the hook spanner with a plastic or rubber hammer. This is most easily done if the cutter head is still mounted in the machine, but it can also be done after the cutter head is removed.

Use protective gloves, and work on a wooden surface so that you do not damage the knives and the saw blade.

Maintenance

⚠ Risk of serious injury if maintenance is neglected.

SH 230 is easy to maintain. Necessary maintenance is set out below.

- ❶ Ensure that the machine's power supply has been disconnected before opening the planer's cover or removing a protective cover.

Compressed air can be very useful for blowing the machine clean each time you open the machine's cover.

After each working day, the entire machine must be cleaned from resin and wood debris. Be extra thorough with the feed rollers' sprung bearings, the in- and out-feed rollers, and the cutter head. Use ethanol as a solvent. Check the tension of the Poly-V belt (under the protective cover). Also check that cables, connections and contacts are in good condition.

- ❶ Wood debris can accumulate under the in- and out-feed rollers' four sprung bearings. This impairs the feeding and increases the risk of the work piece being hurled out of the machine.
- ❶ Check that the teeth of the kick-back guard are clean and that they swing back by their own weight.

Make sure that the following parts are well lubricated. Use a suitable chain oil (e.g. ISO VG 68):

- The feed roller's bearings. Lower the table to its lowest position.
- The chain (under the protective cover) that drives the feed rollers.

When the machine is in use, the table should be regularly cleaned and treated with a lubricant, e.g. thin oil or wax. Logosol's lubricant (art. no. 7500-001-5050) is especially developed for wood processing machines. Avoid getting the lubricant on the feed rollers.

- ❶ Regularly check that the motor compartment remains free of wood debris. If the compartment fills, the motor may not get sufficient cooling.

If the machine is not going to be used for some time:

- The power should be disconnected, and the machine thoroughly cleaned.
- Fix paint damages that may have occurred; clean with ethanol, scrape off rust, and fill the damages with automotive paint. This prevents creeping rust that can worsen the damage.
- Lubricate the table surface and the parts mentioned above, using a good oil (ISO VG 68) and a brush or a wad of cotton waste. Also lubricate the planing and moulding knives, and the circular saw blade. The machine should preferably be stored in a heated room. If this is not possible, ensure that the machine is well covered, and not in direct contact with the ground.

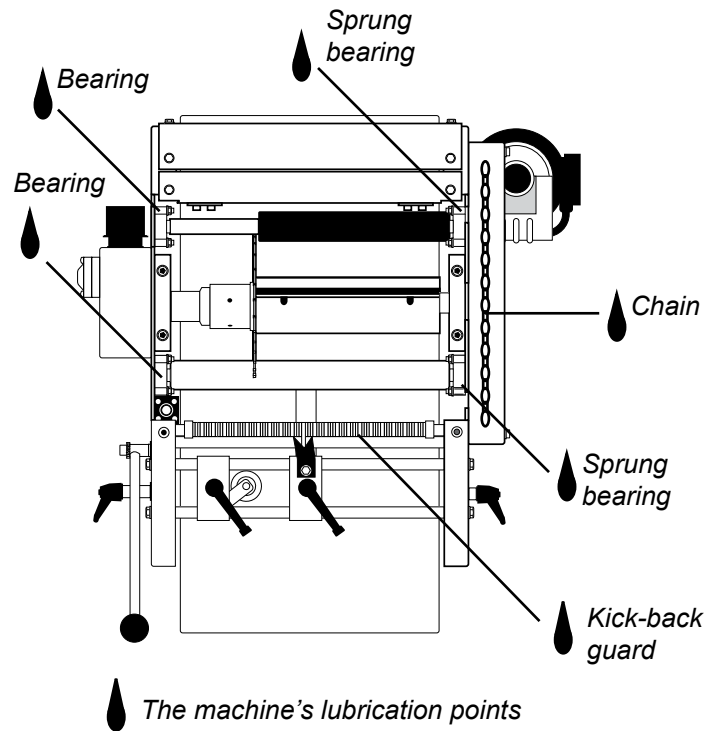

The Feed

For the feed to work well, the feed rollers must be kept from resin and wood debris.

The feed rollers are spring suspended and mounted in the frame. You can experiment with the feed pressure by adjusting the nuts against which the springs push. These nuts are on the underside of the rollers.

- ❶ The rollers should be parallel with the work piece, and not tilt to any direction.

If a thin working piece is processed, and the springs are equally hard tensioned on the left and the right side, the feed roller can tilt, which will give a result below par.

Note the basic setting before starting to adjust the nuts, so that you can easily return to it later, if the new setting turns out to be wrong. Usually, the springs should be more tensioned on the sawblade side, especially if thin work pieces are processed. To check the roller pressure, disconnect the power, lower the table, place a work piece under the cutter head, and raise the table so that the feed roller is pushed upwards. Both sides of the feed roller should spring up equally much.

The feed rollers are run by a separate motor and chain transmission.

The chain can be tightened by turning the white eccentric – the chain tensioner (19) – around which it runs. To allow the rollers' springing to work, the drive chain must be relatively slack.

If the chain jumps on its sprocket (a rattling sound is heard) you can carefully turn the eccentric chain tensioner. This slightly tensions or slackens the chain.

- ❶ If the chain is overtightened, the rollers will lock when the work piece is pushed into the machine.

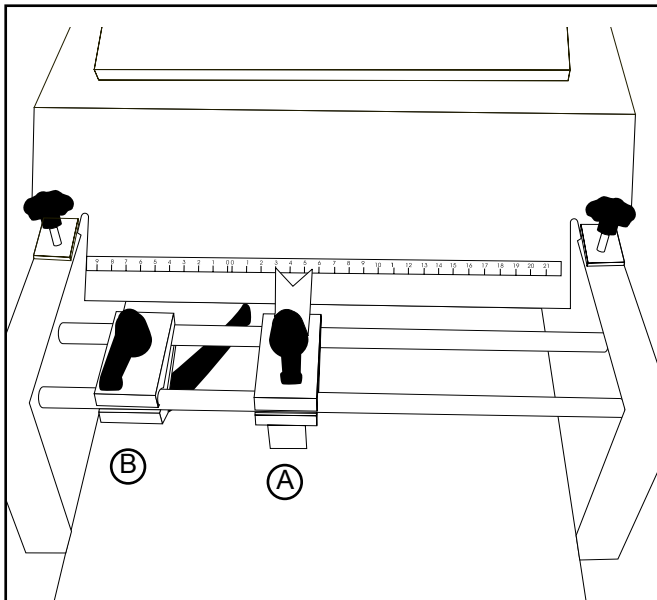

Four Functions

Dimensioning: With the help of the scale on top of the planer, set the fence (A) to the desired width and lock it with the locking knob. When dimensioning, the right scale and the left tip of the double pointer indicate the board's width. Adjust the spring loaded fence (B) so that the work piece is pressed against the other fence (A). Lock it in place by turning the locking knob. Using the table lever and the scale, set the planer table to the desired board thickness. Lock it with the two locking handles. Set the height of the feed tables by releasing the locking handles on the machine's sides, and adjusting with the lever on the left side. Tighten the locking handles again.

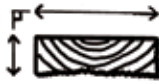

Resawing: With the help of the scale, set the fence (A) to the desired width and lock it with the locking knob. Adjust the spring loaded fence (B) so that the work piece is pressed against the other stop (A). Lock it in place by turning the locking knob. Using the height adjusting lever, set the table to the same height as the work piece, and lock it with both locking handles. If you are going to make several battens or blanks of the same dimensions, the fence and the spring loaded fence should change places with each other. The left scale will then indicate size against the right tip of the double pointer.

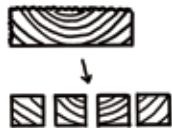

Planing: Set the fence (A) slightly outside, or in line with the saw blade. Push the spring loaded fence (B) all the way to the left. Adjust to the desired height using the table lever and its scale. Lock with both locking handles.



Moulding: Use the machine to cut the work pieces to a suitable size. Next, fit the moulding knives and the knife clamping gibs in the cutter head. Loosen the top cover/chip duct on the hood and set (or remove) the adjustable chip breaker. Make a test piece and adjust the knives as necessary.



ⓘ Always check that the cutter head can rotate freely, and that there are no tools or loose screws in the machine.

Planing Tips

- If you have a very poorly sawn board or if, for any other reason, you wish to remove a large amount of wood, set the planer so that it just planes as much as it can cope with. Run the board through the machine several times until you can set the desired dimensions.
- Try to avoid timber that is too crooked – planing will not make it much straighter.
- Machine a board to size, and measure its exact width. Then calibrate the double pointer on the fence (A) to this. Loosen the screw that holds the pointer to the side of the table, fine-tune and tighten.
- When you have finished making a moulding that you know you will be making again, feed in an approx. 1 metre (3.28 ft) long board and shut the machine off when the end of the board is even with the table edge. Lower the table and remove the board. The next time the machine will be set up for that moulding, the board can be used as a template for both the cutter and the fence.
- If the knives in the upper cutter protrudes too much, the final feed roller will not engage. Recommended projection is 1 mm.
- If a large amount of boards of the same dimension is to be processed, you can place a wooden block on the in-feed table. This way you can quickly direct the boards laterally before feeding them into the machine. (Attention: Risk of straightening planing. Another alternative when processing crooked timber is to draw a mark on the table.)

Worth Knowing...

Which steel quality for which planing?

Alloyed tool steel (SP) also referred to as carbon steel, is hardened by heating and cooling. SP should be used when only a small amount of workpieces is to be processed. It is cheap but can lose its edge already after 300 linear metres (984 linear ft). Amongst other things, it is the heat generated during planing that causes the SP knives to lose their edges. SP can tolerate 300 degrees centigrade before damage sets in. The cheap knives that can be found in a variety of catalogues and hardware stores are made of SP and cannot be compared with HSS.

HSS (high speed steel or cobalt steel) is the quality we recommend in the vast majority of cases. It is roughly twice as expensive as SP but, in compensation for this, holds its edge for around 2000 linear metres (6560 ft). Thus, in the long run, the economy is considerably better. HSS tolerates 700 degrees centigrade without being damaged.

Tungsten carbide tipped steel (TCT) is the most wear-resistant steel quality. TCT's hardness makes the knives almost as brittle as glass. Due to this edges cannot be ground at such sharp angles as HSS and SP. Consequently, TCT gives inferior results in some materials. TCT costs 8-10 times more than SP, but holds its edge up to 6000 linear metres (19680 linear ft). TCT tolerates 1000 degrees centigrade without being damaged. Remember to handle TCT knives carefully so that they do not crack. Always place cutters on a soft surface.

Some special cases: **Pine:** Use HSS or SP. TCT gives an inferior finish. **MDF board:** use only TCT. **Hardwood:** SP cannot be used for planing hardwood. Preferably use a cutter head with four knives (art. no. 7000-000-9094).

The cutter head

SH230 is delivered with HSS planing knives in the cutter head. TCT knives are also available. Upper and lower cutter head can also be equipped with holders for replaceable, thinner knives (so-called indexable inserts) of HSS or TCT.

Moulding knives can be mounted in the cutter head at the same time as the planing knives. This means that the machine can mould and plane in a single operation. There is a wide range of 40 mm (1.6") moulding knives. These can be combined to produce the desired moulding.

Custom-made knives can be ordered from Logosol. These can also be combined to make many different mouldings with a few knives.

Moulding and straightening planing

A moulding planer such as SH230 should not be used for straightening the board. It should only cut the workpiece to size and mould it. For this reason the machine's fence should be as short and as close to the cutting unit as possible to avoid a straightening effect. Panels and trims are normally not straightened.

A straightening planer makes the sides of a workpiece straight, but does not dimension it. A straightening planer should have long tables that guide the workpiece straight over the cutter. After that, the work piece has to be run through a planer, a dimension planer or a moulder in order to get the correct width and height. Normally, only short workpieces are straightened, e.g. for use in furniture or window production.

These two types of machines should not be confused. They each have their own separate and important function.

Wood

Wood shrinks as it dries. The greatest shrinkage occurs when the wood dries from a 25% to a 10% moisture content. To obtain good surfaces, wood should not be planed if the moisture content is higher than 20%. This is roughly as dry as wood can get with outdoor drying. Thus, wood should preferably be stored indoors before planing.

There is little shrinkage along the board in the direction of the fibres. In most cases, this does not have to be taken into account. Along the annual growth rings, wood shrinks around 8%, across them the figure is about 5%. Therefore, it is better to have 'standing' growth rings in boards.

Boards warp and crack with time. To avoid this problem as much as possible, the timber should in most cases be turned so that the heart side is the visible surface.

To ensure that the wall is as tight as possible when working with cove boarding, the outer boards should be turned heart side out and the inner boards heart side in.

Results

Hard materials give better results than soft materials. Small indentations resembling tiny, light-coloured flames are caused by chips collecting at the edge of a knife and being pushed down into the wood. This phenomenon increases as knives lose their edge.

Visible knife marks on the planed wood are most often due to the knives not being set at the same height or the workpiece not being pushed hard enough against the table or the fence during machining. A too high feed speed can also give visible knife marks.

Keep the feed rollers free of wood debris. The out-feed roller is particularly important as debris attached to this can leave marks on the planed surface.

Boards that are too warped or crooked should be straightened in a straightening planer or be put through a dimension planer before the final machining.

Safety Instructions for SH230 Moulding Knives

⚠ Applies to all moulding knives with a profile depth over 12 mm (0.5").



Some of the above mouldings are examples of machining where the cutter has cut completely through the workpiece.

⚠ **The risks are far greater when using these knives.** Be extra careful and attentive when using them.

⚠ **Risk of fatal injury! Risk of the moulding knives coming into contact with the table during operation. Steel fragments can then be thrown out of the machine at high speeds.**

⚠ When using knives with a profile depth over 12 mm (0.5"): Never start the machine if the wooden table guard and the fence for width adjustments are not fitted. The fence serves as a depth limiter and prevents the knives from coming into contact with the surface of the planing table.

⚠ **Risk of fatal injury! Risk of cut off wooden mouldings being thrown out of the machine at high speeds.**

⚠ **Respect the safety distance.** Make some kind of demarcation according to the instructions on page 5. Never stand in front of the in-feed side during operation. Ensure that there are no children near.

⚠ **Before starting SH230 with these knives fitted:** Check that the cutter head can rotate freely, and read the machine's safety instructions.

Instructions:

Using the six Allan screws supplied, fit the wooden table guard to the planing table. The holes in the planing table are threaded. Use only the wooden table guard (art. no. 7000-000-0200) supplied from Logosol.

When the table guard is mounted on the planing table and the side fence is correctly positioned in the machine, the moulding knives can be fitted (see manual SH230).



1. Lower the table to its lowest position.
2. Check that the cutter head can rotate freely.
3. Close the protective cover and start the machine (see manual SH230).
4. Standing by the side of the machine, slowly raise the planing table until the wooden table guard touches the fence. The moulding knives will now cut one or two millimetres into the wooden table guard.
5. Lower the planing table to the desired height.

When the machine's knives are being reset, always repeat steps 1 to 5.



Wooden table guard and fastening screws (screws included). Art. no: 7000-000-0200.

Examples of Mouldings Made Using the SH230 Moulding Knife Set



Step 1

Step 2

The Result

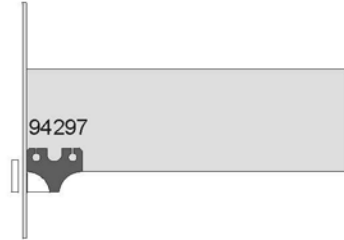

Quarter Round

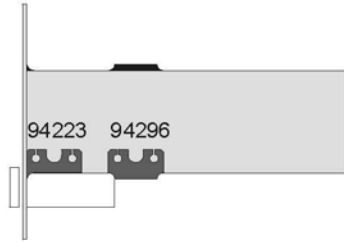

Decking

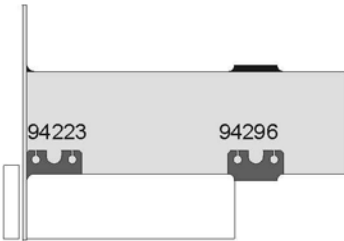

Stud

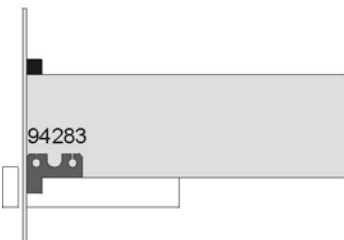

Panel

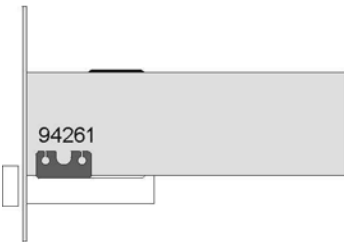

Casing

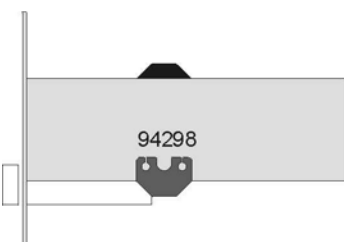

Skirting Board

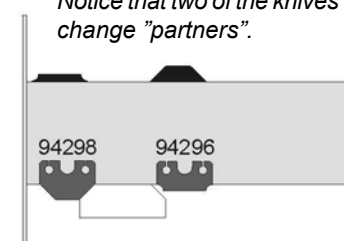

Crown Moulding

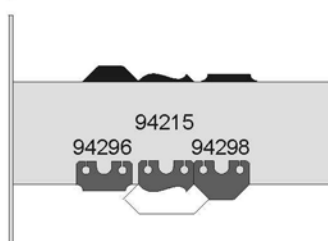
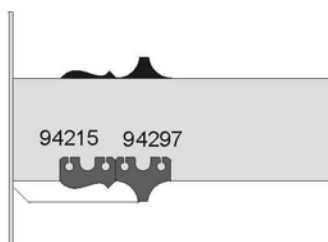
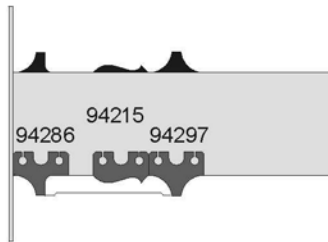
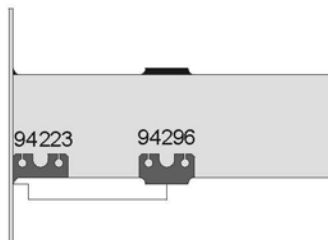
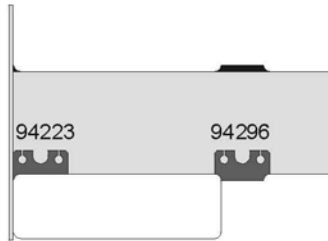

Notice that two of the knives change "partners".

Technical Data

<i>Machining dimensions</i>	Max. material width	310mm
	Max. planing width	230mm
	Max. planing height	52 mm
	Min. planing height*	15 mm
	Max. resawing height	52 mm
<i>Cutting equipment</i>	Cutter head diameter	72 mm
	Planing knives 2 x RPH 230 mm	HSS
	Chip thickness	6 mm
	Saw blade	SH230 ø 180 mm
	Speed of rotation	5400 rpm
	Moulding knives	Logosol
	Cutter head stopping time	approx. 7 sec.
<i>Chip handling</i>	Chip duct diameter	100 mm
	Required chip extractor capacity	700 m ² /h
<i>Feed</i>	Feed speed	approx. 6m/min
	Number of rollers	2
<i>Dimensions</i>	Length	700 mm
	Width	500 mm
	Height	550 mm
	Weight	approx. 70 kg
<i>Electrical system</i>		
Power supply	CCA16 A, 380 V 50 Hz 3-phase	
Coupled enclosure, degree of protection	IP54	
Continuous output, main motor	3kW	
Continuous output, feed motor	0.18 kW	
Main disconnecter: Unplug the power cable.		
<i>Sound levels</i>	Sound pressure level	100.4 dB (A)
	Sound pressure power level	107.6 dB (A)
<i>Accessories</i>	Stand (height 500 mm), chip duct, in- and out-feed tables, chip extractor, flexi hose, moulding knives, etc. See the <i>Planers and Accessories</i> catalogue, available cost-free from Logosol (Catalogue art.no: 7005-000-0510)	

* With wood table guard 7000-000-0200, 4 mm.

Circuit Diagram

⚠ Lethal voltage! Faulty connection can result in a fatal accident.

⚠ Note that only qualified electricians are authorized to open/access the electrical system.

⚠ Ensure that the power is disconnected before opening the electrical system.

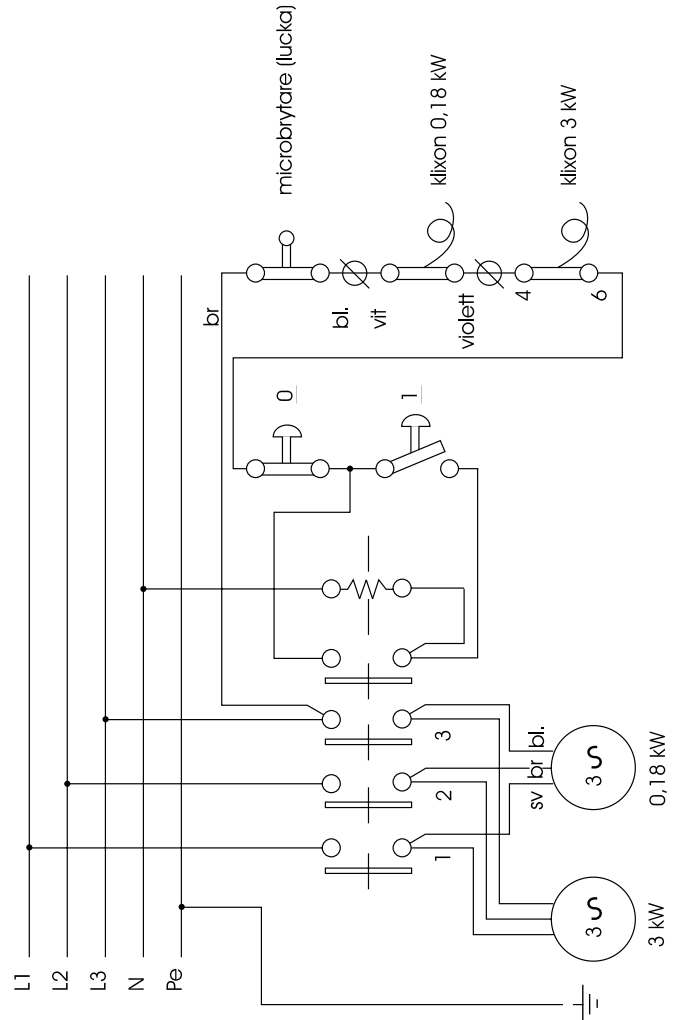

Declaration of Conformity

The manufacturer, Logosol AB, Industrigatan 13, S-871 53 Härnösand, Sweden, tel. +46 611 18285, hereby declares that SH 230, with art. no. 7202-000-0230, is manufactured in accordance with:

Machinery Directive 98/37/EG, EMCdirective 2004/108/EG, and LVD-directive 2006/95/EG,

and that it is manufactured in accordance with the following harmonized standards: EN ISO 12100-1, -2:2003, EN 60204-1:2006, EN 61000-6-1, -3.

Certifying body:

SMP Swedish Machinery Testing Institute AB 0404, Uppsala, Sweden has issued:

Type approval certificate: 404/07/1213 404/01/812

Machines with art. no. 7202-000-0230 correspond with the one examined by SMP.

Härnösand 2007-11-01

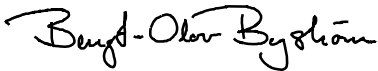

Bengt-Olov Byström, MD



 **LOGOSOL**
Swedish wood processing products

LOGOSOL Sweden

Industrigatan 13 SE-871 53 HÄRNÖSAND
Tel. 0611-182 85 Fax 0611-182 89
www.logosol.se
info@logosol.se

LOGOSOL Norway

Nedre-Steinstan, Röra NO-7670 Inderoy
Tel. 741 55 251 Fax 741 54 712
www.logosol.no
info@logosol.no

LOGOSOL USA

P.O.box 660 Madison Mi 391 30
Tel. 601-856 18 89 Fax 601-856 95 35
www.logosol.com
info@logosol.com

LOGOSOL GmbH Deutschland

Mack Strasse 39 DE-88348 Bad Saulgau
Tel. 07581-506460 Fax 07581-506462
www.logosol.de
info@logosol.de

LOGOSOL UK

The Sawmill, Abbey St. Bathans, DUNS Berwickshire TD11 3TX
Tel. 01361 840 251 Fax 01361 840 389
www.logosol.co.uk
info@logosol.co.uk